

Varenummer: 2031100M20125C4U

Beskrivelse: E+G Justerfod  
GN 31-100-M20-125-C4-U

Note: U Uden møtrik, sekskant i toppen, spændeflade i bunden

## Mål

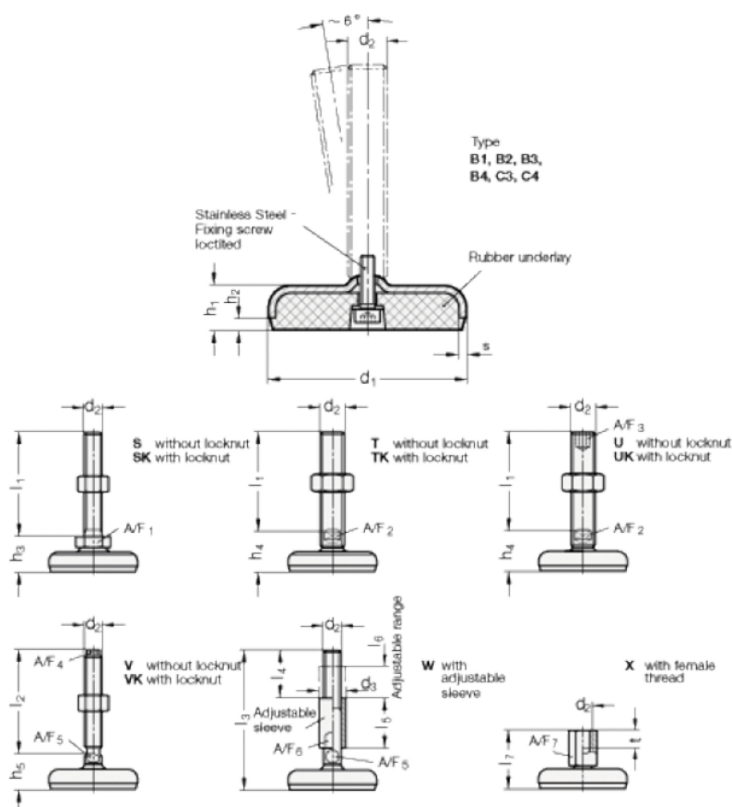

A/F2	= 15	s = 3
A/F3	= 10	
d1	= 100	
d2	= 20	
h1	= 20	
h4 +4.0/0	= 35	
l1	= 125	